

MDS Medical AC-DC Open Frame

12 Volt, 100 Watt / MDS-100BPS12 BA

100BPS12 BA

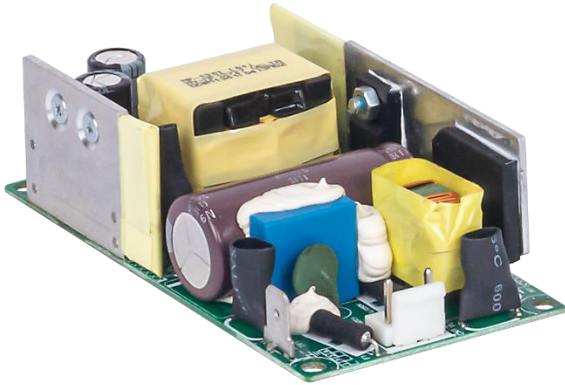

Highlights & Features

- Safety Approvals to IEC 60601-1 & IEC 62368-1
- Compliant with IEC 60601-1-2 4th Ed. Requirements
- Compact size 2"x4"
- Low touch current (<0.1 mA Normal & <0.3 mA single fault)
- Over-Voltage/Load/Temperature & Short Circuit protections
- 1 Million Hours MTBF
- 2 x MOPP (means of patient protection)

Safety Standards



CB Certified for worldwide use

Model Number:	MDS-100BPS12 BA
Unit Weight:	150 grams (5.3 ounces)
Dimensions (W x L x H):	50.8 x 101.6 x 31.8 mm (2.0 x 4.0 x 1.25 in)

General Description

The MDS series of embedded power supply come with universal AC input at 90 Vac to 264 Vac. Other features include low touch current, risk management report available and the electric shock protection comply with 2 x MOPP. The MDS series is certified for EMC standards according to EN/BS EN 55011 for industrial, scientific and medical (ISM) radio-frequency equipment and EN/BS EN 55032 for Information Technology Equipment (ITE) radio-frequency equipment.

The MDS series of embedded power supply come with both medical and ITE safety approvals including UL/cUL/CE and CB certification and are fully compliant with RoHS Directive for environmental protection.

Model Information

Medical AC-DC Open Frame

Model Number	Input Voltage	Output Voltage	Conversion Current Output	Forced Air Current Output
MDS-100BPS12 BA	90-264 Vac	12 Vdc	6.6 A	8.4 A

Model Numbering

MDS <small>Medical Power Supply</small>	-	100 <small>Max wattage in the product series. Maybe lower at some voltage. 100 → 100 W</small>	BPS <small>Family Code</small>	12 <small>Output Voltage Single Output: 12 for 12 V</small>	□ <small>Blank</small>	BA <small>Delta STD</small>
---	---	--	--	---	---------------------------	---------------------------------------

MDS Medical AC-DC Open Frame

12 Volt, 100 Watt / MDS-100BPS12 BA

Specifications

Input Ratings / Characteristics

Nominal Input Voltage	100-240 Vac
Input Voltage Range	90-264 Vac
Nominal Input Frequency	50-60 Hz
Input Frequency Range	47-63 Hz
Input Current (max)	2.5 A @ 100 Vac, 1.25 A @ 240 Vac
Efficiency (typ.)	87%, Reference Fig. 1
Standby Power (max)	0.3 W
Inrush Current (typ.)	40 A @ 115 Vac, 80 A @ 230 Vac
Touch Current (max)	0.1 mA @ 264 Vac NC ¹⁾ , 0.3 mA @ 264 Vac SFC ²⁾
Earth Leakage Current (max)	0.15 mA @ 264 Vac NC ¹⁾ , 0.3 mA @ 264 Vac SFC ²⁾

1) NC: normal condition

2) SFC: single fault condition

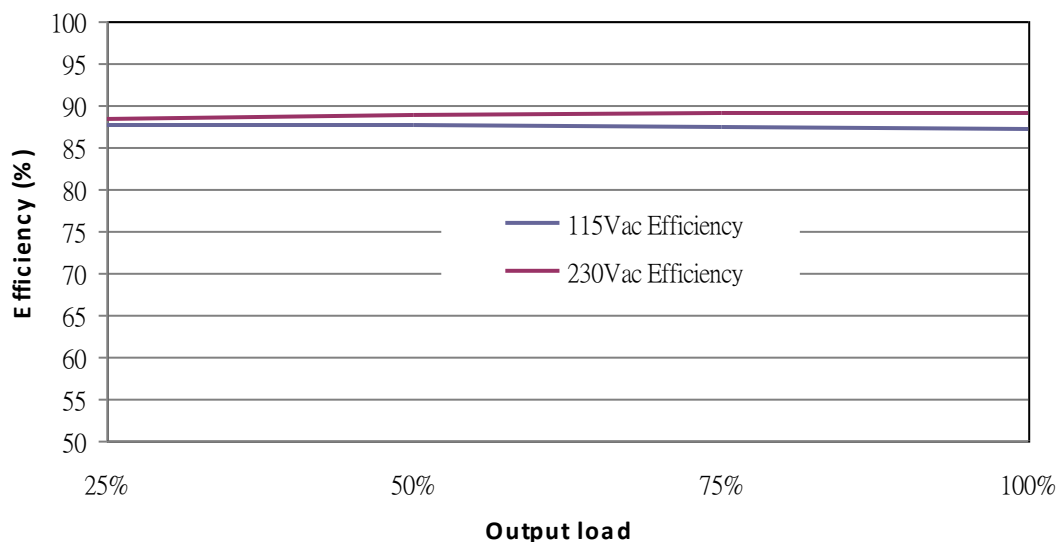

Fig. 1 Efficiency versus output load

Output Ratings / Characteristics

Nominal Output Voltage	12 Vdc
Total Regulation	±1.5%
Output Current	8.33 A with 10 CFM force air, 6.67 A for convection
Output Power	100 W with 10 CFM force air, 80 W for convection
Line Regulation (max)	±0.5%
Load Regulation (max)	±1%
Ripple & Noise (typ.)	76 mV pk-pk @ Full load, Reference Fig. 2
Start-up Time (max)	3000 ms @ 115 Vac
Hold-up Time (min)	10 ms @ 115 Vac
Dynamic Response (Overshoot & Undershoot O/P Voltage)	±3% @ 50-100% load

*Periodic and Random Deviation

MDS Medical AC-DC Open Frame

12 Volt, 100 Watt / MDS-100BPS12 BA

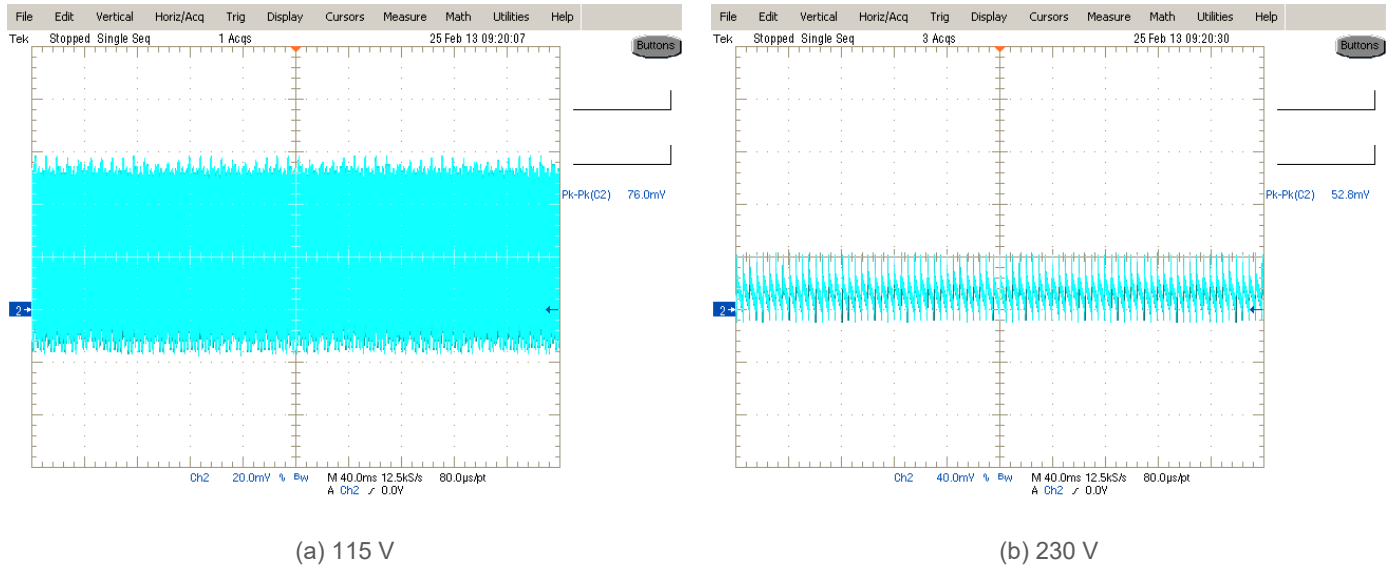
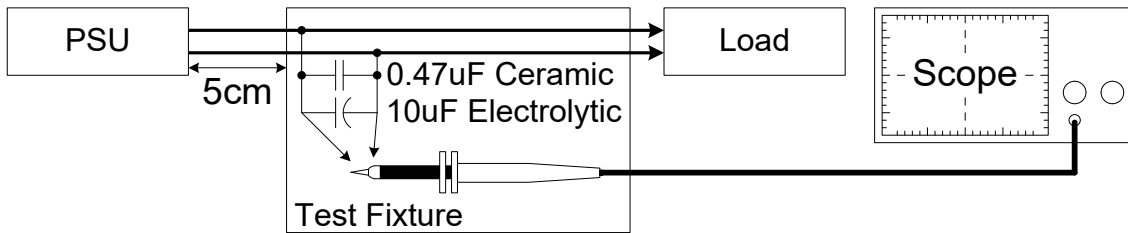

Fig. 2 Ripple & Noise example, 20 MHz BW

Ripple & Noise measurement circuit



Mechanical

Dimensions (W x L x H)		50.8 x 101.6 x 31.8 mm (2.0 x 4.0 x 1.25 in)
Weight (typ.)		150 grams (5.3 ounces)
Terminal	Input	JST 2P
	Output	JST 4P

Environment

Surrounding Air Temperature	Operating	-10°C to +70°C
	Storage	-40°C to +85°C
Power De-rating	-10°C to +50°C 100% load 50°C to 70°C de-rate power by 2.5% / °C, See Fig. 3	
Operating Humidity	10-95% RH (Non-Condensing)	
Altitude	Operating	Up to 5,000 meters (up to 16,400 feet or 106 - 54k Pa)
	Non-Operating	Up to 5,575 meters (up to 18,290 feet or 106 - 50k Pa)
Shock Test	Non-Operating	50 G, 11 ms, 3 shocks for each direction
Vibration	Non-Operating	5-500 Hz, 2.09 Grms, 20 minute for each three axis

MDS Medical AC-DC Open Frame

12 Volt, 100 Watt / MDS-100BPS12 BA

Protections

Over Voltage (max)	150%, Latch Mode
Over Load / Over Current (max)	170% of rated load current, Hiccup Mode, (Non-Latching, Auto-Recovery)
Over Temperature	Hiccup Mode, (Non-Latching, Auto-Recovery)
Short Circuit	Hiccup Mode, (Non-Latching, Auto-Recovery)
Protection Against Shock	Class I with PE* connection

*PE: Protective Earth

Reliability Data

MTBF (typ.)	1 Million Hours based on Telcordia SR-332
-------------	---

Safety Standards / Directives

Medical Safety	IEC 60601-1 CB report, EN 60601-1 CAN/CSA-C22.2 No. 60601-1, ANSI/AAMI ES 60601-1	
ITE Safety	IEC 60950-1, IEC 62368-1 CB report CCC GB 17625.1; GB 4943.1; GB/T 9254.1	
CE	In conformance with EMC Directive 2014/30/EU and Low Voltage Directive 2014/35/EU EN 60601-1: 2006 + A11: 2011 + A1L 2013 + A12: 2014 & EN 60601-1-2: 2015	
UKCA	In conformance with Electrical Equipment (Safety) Regulations 2016 and Electromagnetic Compatibility Regulations 2016, Medical Devices Regulations 2002 (UK MDR 2002)	
Galvanic Isolation	Input to Output	4000 Vac
	Input to Ground	1500 Vac
	Output to Ground	500 Vac

MDS Medical AC-DC Open Frame

12 Volt, 100 Watt / MDS-100BPS12 BA

EMC (Compliant with IEC 60601-1-2 4th Ed. Requirements)

EMC / Emissions		EN/BS EN 55011, EN/BS EN 55032
Harmonic Current Emissions	IEC 61000-3-2	Meet Class A limit
Voltage Flicker	IEC 61000-3-3	
Immunity to		
Electrostatic Discharge	IEC 61000-4-2	Level 4 Criteria A ¹⁾ Air Discharge: 15 kV Contact Discharge: 8 kV
Radiated Field	IEC 61000-4-3	Criteria A ¹⁾ 80 MHz-2700 MHz, 10 V/m AM modulation 385 MHz-5785 MHz, 28 V/m Pulse mode and other modulation
Electrical Fast Transient / Burst	IEC 61000-4-4	Level 3 Criteria A ¹⁾ : 2 kV
Surge	IEC 61000-4-5	Level 3 Criteria A ¹⁾ Common Mode ³⁾ : 2 kV Differential Mode ⁴⁾ : 1 kV
Conducted	IEC 61000-4-6	Level 2 Criteria A ¹⁾ 150 kHz-80 MHz, 3 Vrms, 6 Vrms at ISM bands and Amateur radio bands
Power Frequency Magnetic Fields	IEC 61000-4-8	Criteria A ¹⁾ Magnetic field strength 30 A/m
Voltage Dips	IEC 61000-4-11	Criteria B ²⁾ 0% U _T , 0.5 cycle (10 ms), 0°/45°/90°/135°/180°/225°/270°/315°/360° Criteria B ²⁾ 0% U _T , 1 cycle (20 ms), 0° Criteria A ¹⁾ 70% U _T , 25 cycle (500 ms), 0° Criteria B ²⁾ 0% U _T , 250 cycle (5000 ms), 0°

1) Criteria A: Normal performance within the specification limits

2) Criteria B: Output out of regulation, or shuts down during test. Automatically restore to normal operation after test.

3) Asymmetrical: Common mode (Line to earth)

4) Symmetrical: Differential mode (Line to line)

MDS Medical AC-DC Open Frame

12 Volt, 100 Watt / MDS-100BPS12 BA

Block Diagram

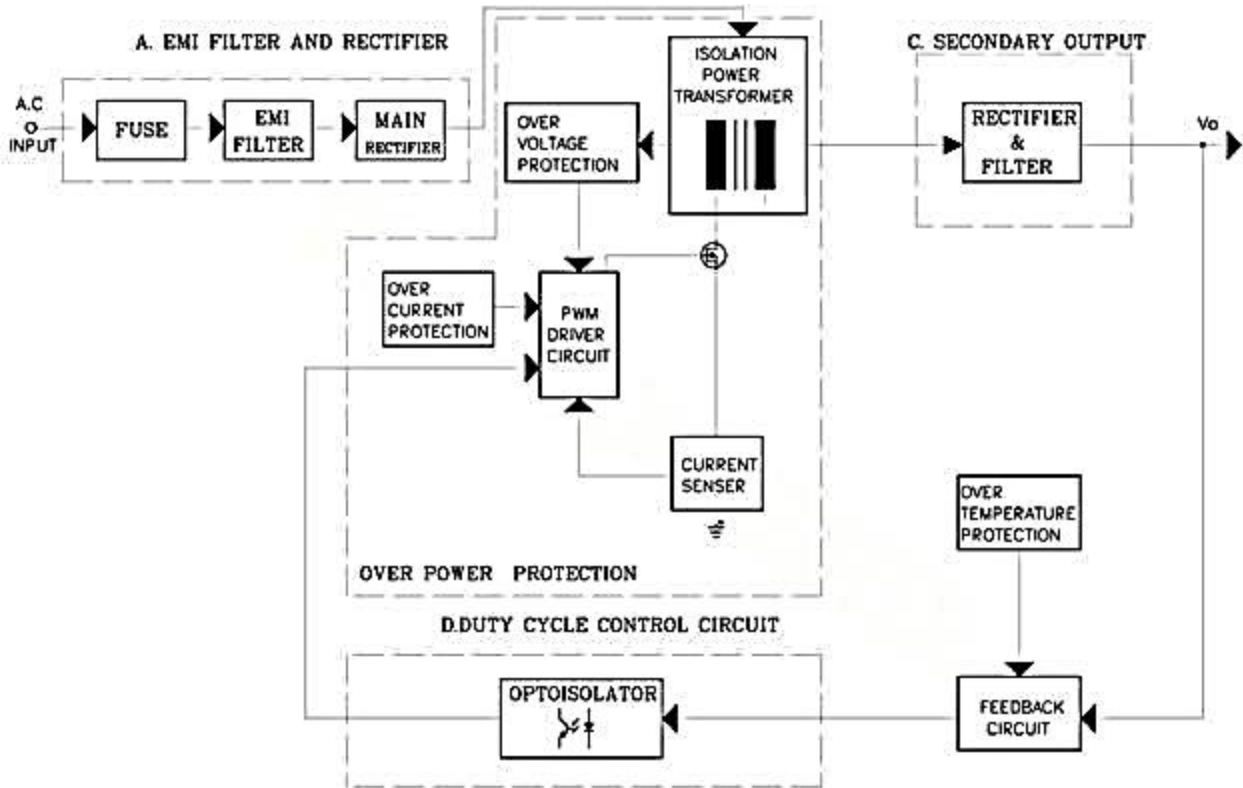

MDS Medical AC-DC Open Frame

12 Volt, 100 Watt / MDS-100BPS12 BA

Dimensions

W x L x H: 50.8 x 101.6 x 31.8 mm (2.0 x 4.0 x 1.25 in)

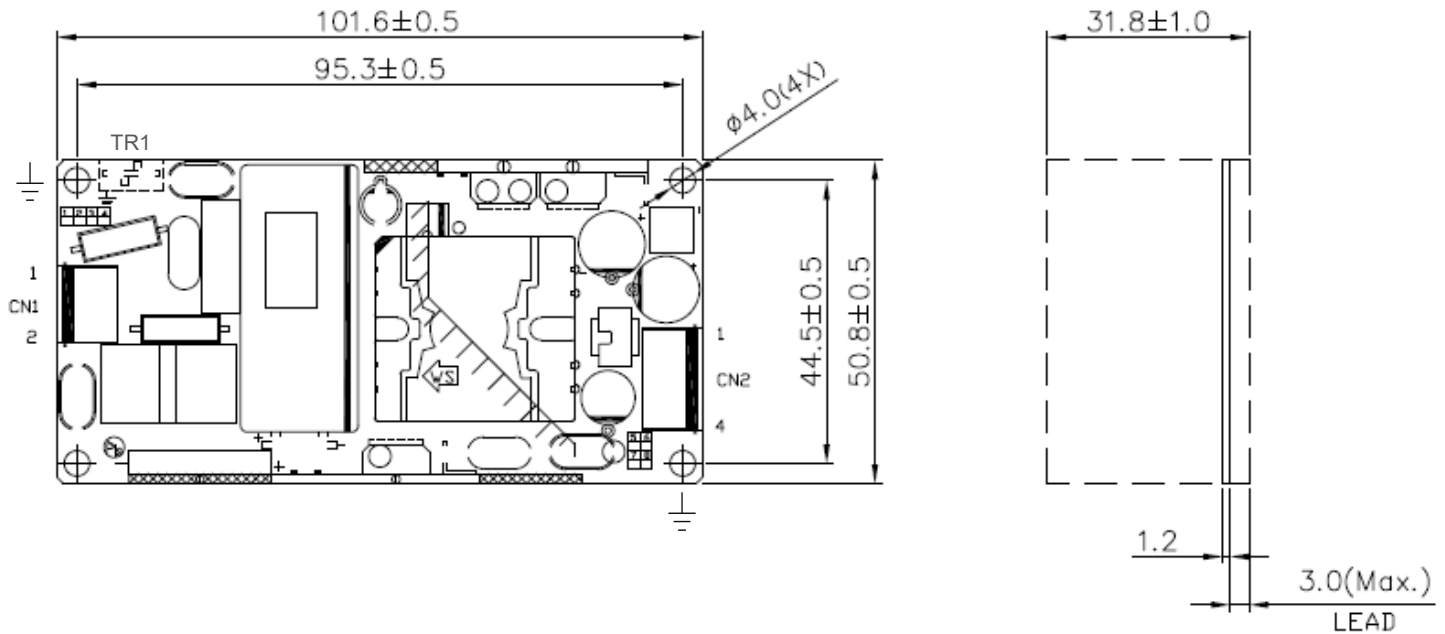

PIN ASSIGNMENT TABLE

ITEM	PIN NO.	FUNCTION	CONNECTOR
CN1 (AC)	1	L	JST: B2P3-VH(LF)(SN) MATING WITH JST: VHR-3N (middle terminal should be blank)
	2	N	
CN2 (DC)	1	+V	JST: B4P-VH(LF)(SN) MATING WITH JST: VHR-4N
	2		
	3	GND	
	4		

TR1 : KANG YANG part number PCH250 mates with KST part number FDFNYD1-250 or equivalent.

Notes

- Dimensions are in mm
- For Open Frame type: There are 4 normal mounting holes. To ensure EMC performance, all mounting holes shall be connected to metal case.
- Method of protective earth connection:
 - a. When system (End products') protective earth connection is connected to system's (or end products') enclosure/cover (afterward named "system" for short).
 1. Two mounting holes which are marked ground symbols in mechanical drawing are needed to link system together by conductive screw
 2. The cable can be connected system to TR1.
 - b. System (End products') incoming protective earth connection can be connected to TR1 on power supply directly.

MDS Medical AC-DC Open Frame

12 Volt, 100 Watt / MDS-100BPS12 BA

Power De-rating

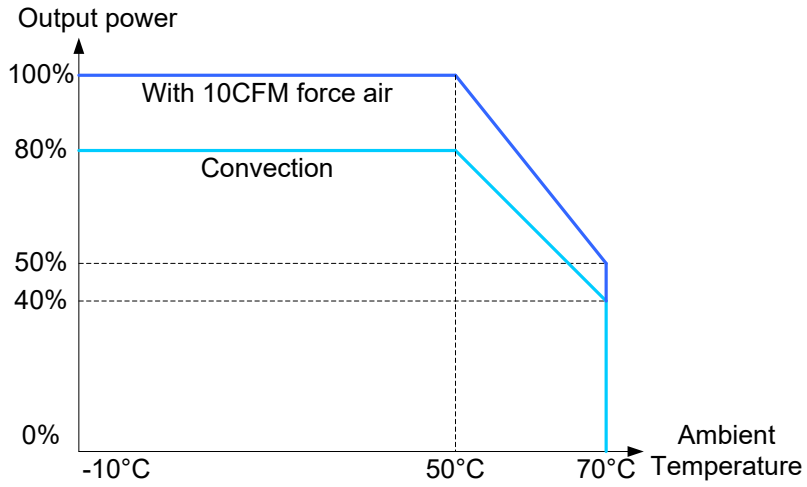
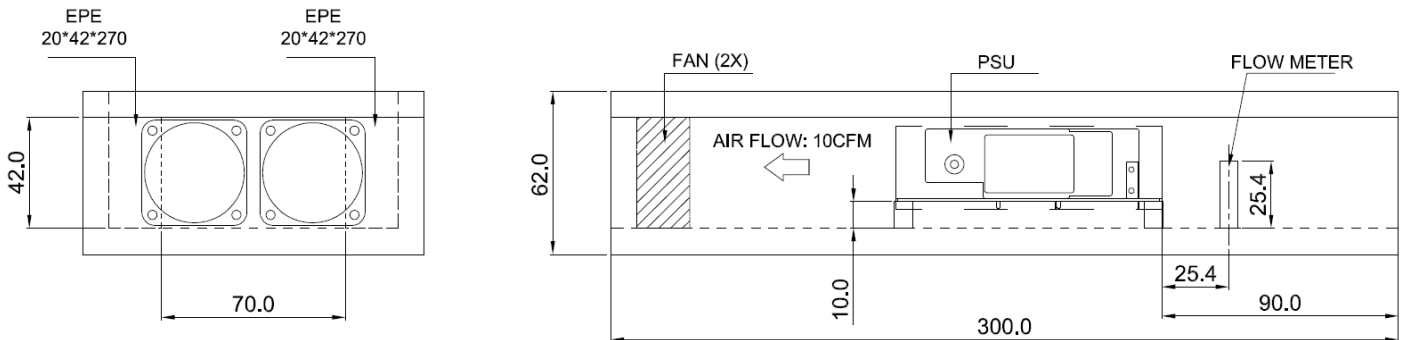

Fig. 3

Load De-rating Fixture and Test Setup. Fan is DELTA Part Number EFB0412VHD



MDS Medical AC-DC Open Frame

12 Volt, 100 Watt / MDS-100BPS12 BA

Functions

Start-up Time

The time required for the output voltage (V_o) to reach 90% of its set value, after the input AC voltage is applied.

Rise Time

The time required for the output voltage (V_o) to change from 10% to 90% of its steady state value.

Hold-up Time

Hold up time is the time when the AC input collapses and output voltage retains regulation for a certain period of time. The time required for the output to reach 95% of its set value, after the input voltage is removed.

■ Graph illustrating the Start-up Time, Rise Time, and Hold-up Time

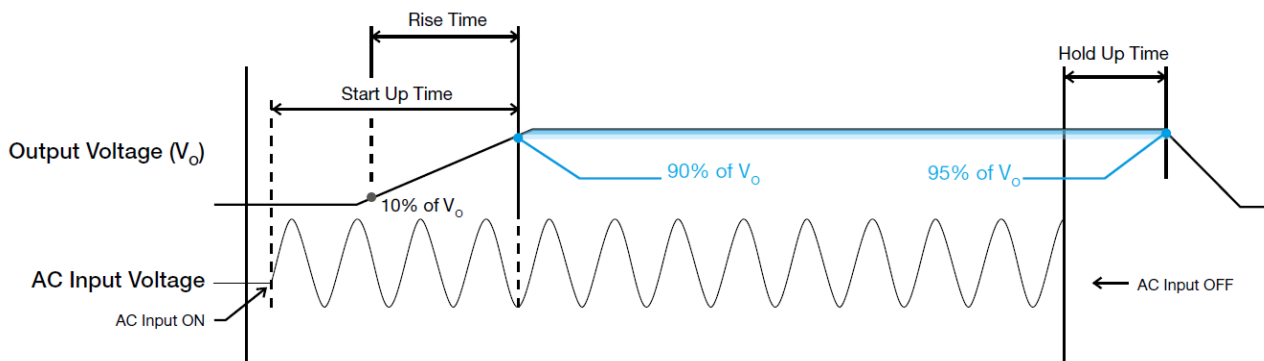

MDS Medical AC-DC Open Frame

12 Volt, 100 Watt / MDS-100BPS12 BA

Dynamic Response

The power supply output voltage will remain within $\pm 3\%$ of its steady state value, when subjected to a dynamic load change from 50 to 100% of its rated current.

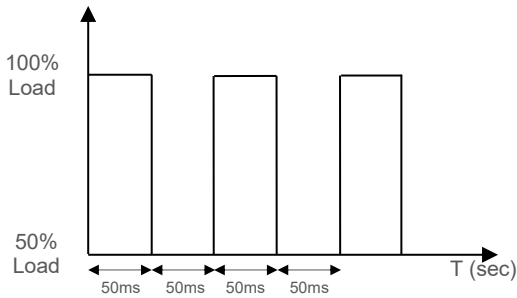

Inrush Current

Inrush current is the input current that occurs when the input voltage is first applied. For AC input voltages, the maximum peak value of inrush current will occur during the first half cycle of the applied AC voltage. This peak value decreases exponentially during subsequent cycles of AC voltage.

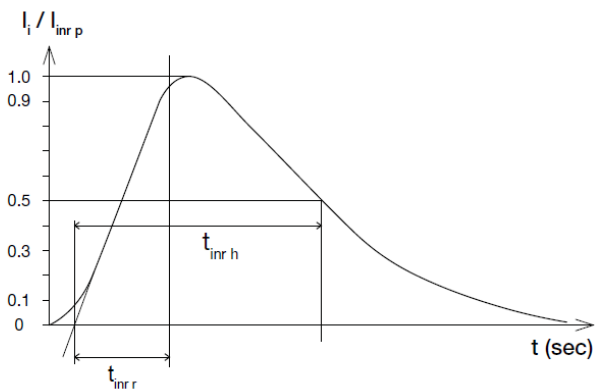

Overvoltage Protection

The power supply's overvoltage circuit will be activated when its internal feedback circuit fails. The output voltage shall not exceed its specifications defined on Page 4 under "Protections". Power supply will latch off, and require removal/re-application of input AC voltage in order to restart.

Short Circuit Protection

The power supply's output OLP/OCP function also provides protection against short circuits. When a short circuit is applied, the output current will operate in "Hiccup mode", as shown in the illustration in the OLP/OCP section on this page. The power supply will return to normal operation after the short circuit is removed.

Overload & Over current Protections

The power supply's Overload (OLP) and Over current (OCP) Protections will be activated when output current is between 110% and 170% of I_o (Max load). Upon such an occurrence, V_o will start to drop. Once the power supply has reached its maximum power limit, the protection will be activated, and the power supply will go into "Hiccup mode" (Auto-Recovery). The power supply will recover once the fault condition causing the OLP and OCP is removed and I_o is back within the specified limit.

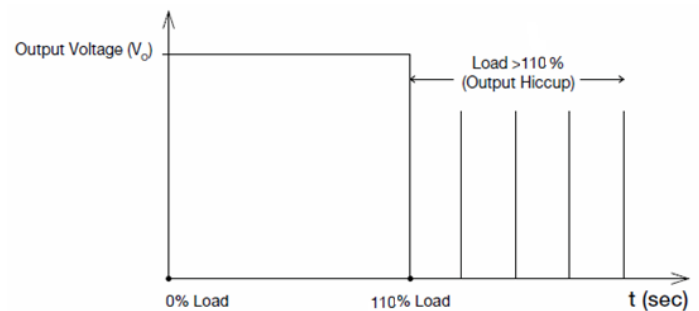

Additionally, if the I_o is $< 110\%$ but $> 100\%$ for a prolonged period of time (depending on the load), the Over Temperature Protection (OTP) will be activated due to high temperature on critical components. The power supply will then go into hiccup mode until the fault is removed; and, the input voltage is removed, then reapplied.

Over Temperature Protection

As mentioned above, the power supply also has Over Temperature Protection (OTP). This is activated when the overload condition persists for an extended duration and the output current is below the overload trigger point but $> 100\%$ load. In the event of a higher operating condition at 100% load, the power supply will run into OTP when the surrounding air temperature is higher than the operating temperature. When activated, the output voltage will go into hiccup mode until the input voltage is removed; then, reapplied, and the surrounding air temperature drops to its normal operating temperature.

MDS Medical AC-DC Open Frame

12 Volt, 100 Watt / MDS-100BPS12 BA

Certificate



Delta has been certified as meeting the requirement of ISO 13485:2016 and EN ISO 13485:2016 for the design and manufacture of switching power supply and adaptor for medical device.



In addition to a UL Total Certification Program (TCP) approved client laboratory for IEC 62368-1. Delta also has participated UL Client Test Data Program (CDTP) for IEC 60601

Attention

Delta provides all information in the datasheets on an "AS IS" basis and does not offer any kind of warranty through the information for using the product. In the event of any discrepancy between the information in the catalog and datasheets, the datasheets shall prevail (please refer to PSU.deltaww.com for the latest datasheets information). Delta shall have no liability of indemnification for any claim or action arising from any error for the provided information in the datasheets. Customer shall take its responsibility for evaluation of using the product before placing an order with Delta.

Delta reserves the right to make changes to the information described in the datasheets without notice.

Manufacturer and Authorized Representatives Information

Manufacturer

Thailand

Delta Electronics (Thailand) PCL.
909 Pattana 1 Rd., Muang, Samutprakarn, 10280 Thailand

Taiwan

Delta Electronics, Inc.
3 Tungyuan Road, Chungli Industrial Zone, Taoyuan County
32063, Taiwan

Authorized Representatives

The Netherlands

Delta Greentech (Netherlands) B.V.
Zandsteen 15, 2132 MZ Hoofddorp, The Netherlands

United Kingdom

Delta Electronics Europe Limited
1 Redwood Court, Peel Park Campus,
East Kilbride, Glasgow, G74 5PF, United Kingdom